

THE PROPERTY OF THE DRAWING IS ESTABLISHED BY LAW. IT IS FORBIDDEN TO PRODUCE OR SHOW IT TO THIRD PART. WITHOUT A WRITTEN AGREEMENT.

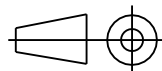
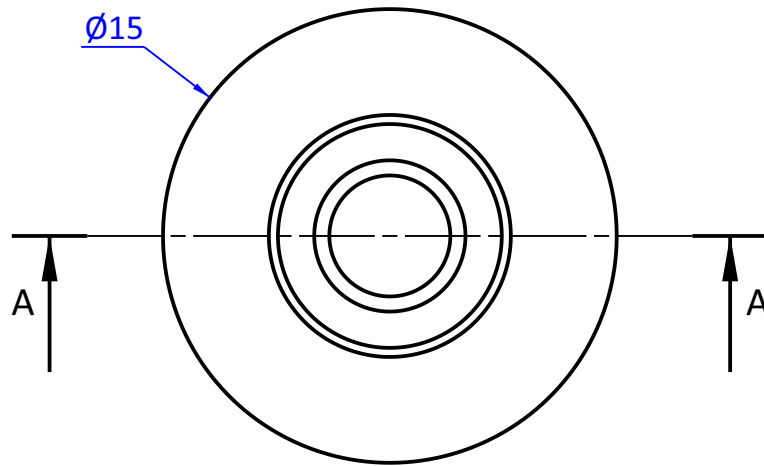
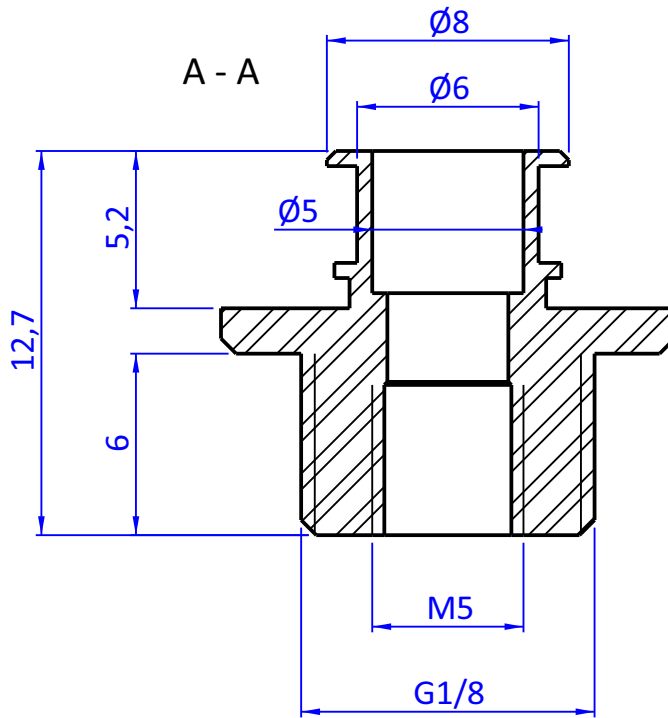

DESIGNED FROM

FPS Automation

REVIEW

A

DATE

02/09/2022

WEIGHT

0,002kg

CODE

CA.08.09.032

Format A4

UNI 936-76

GENERAL TOLERANCE

UNI - ISO 2768

CLASSE f

DESCRIPTION

CA.08.09.032